

# INSTRUCTION

Flat Slim Square  
312667.002.19

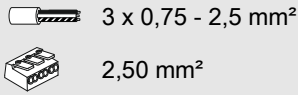

~ 220 - 240 V 50/60 Hz IP 40, IP 65 IK07



Umgebungstemperatur /  
temperature ambiante  
=> -20 °C ... + 35 °C

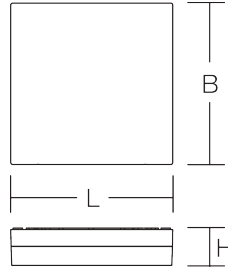
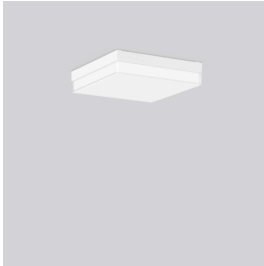

L 300, B 300, H 67



4,175 kg



$\Phi$  [lm]

$P_{\square}$  [W]

$P_{\circ}$

LED

2400

21

1 x 24 W

CCT [K]

CRI

RG  $\square$

EEK  $\square$

4000

80

RG 1

D

$I_{max}$   $I_{max}/2$   
T50

B10  
[St.]

B16  
[St.]

C10  
[St.]

C16  
[St.]

$\cos \varphi$

5 A / 50  $\mu$ s

31

50

52

85

0,95

$f_{min}$  -  $f_{max}$   
[MHz]

$p_{EIRP}$  [mW]

5725 - 5875

0,2

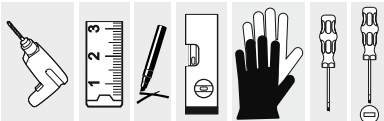



### Allgemeine Sicherheitshinweise

- Der elektrische Anschluss muss ordnungsgemäß nach geltenden Normen und den nationalen sowie internationalen Sicherheits- und Unfallverhütungsvorschriften erfolgen.
- Beschädigte Leuchten dürfen nicht betrieben werden.
- Keine Haftung für Schäden durch unsachgemäßen Einsatz.
- Bei Instandsetzung nur Originalteile verwenden.
- Tragfähigkeit der Decke und Befestigungselemente sicherstellen.

### Betrieb der Leuchte

- Die unzulässigen Umgebungstemperaturen reduzieren die Lebensdauer der Leuchte, im Extremfall droht der Frühausfall.
- Zur Vermeidung von EMV-Problemen die Durchgangsverdrahtung nicht entlang der Leuchtenverdrahtung führen.
- Steuereingänge von dimmbaren Leuchten mit handelsüblichen für Netzspannung geeigneten Leitungen anschließen.

### Manipulationen unserer Produkte sind unzulässig

Veränderung, Umarbeitung, Umkennzeichnung von Produkten sowie deren Verpackung sind unzulässig und verletzen u.a. unsere eingetragenen Warenzeichenrechte. Solche Modifikationen können technische Eigenschaften unserer Produkte negativ beeinflussen, diese zerstören und möglicherweise Folgeschäden an anderen Objekten verursachen. Für durch derartige Modifikationen verursachte Schäden kann der Hersteller in keinem Fall verantwortlich gemacht werden.



### General Safety Information

- Electric connection must be appropriate according to all applicable standards and other national and international safety and accident prevention regulations.
- Damaged luminaires must not be operated.
- No liability is accepted for damages resulting from improper use.
- Use genuine parts only for repair.
- Ensure stability of the ceiling and fastening elements.

### Operation of the luminaire

- Exceeding the permissible ambient temperature will reduce the luminaire's lifecycle, resulting in premature failure in extreme cases.
- Avoid ESD problems by not routing feed-through wiring directly along the wiring of the luminaire.
- Connect control inputs of dimmable luminaires with standard cables suitable for power supply voltage.

### Manipulation of our products is not permitted

Modifications, reworking, re-labelling of products as well as their package is not permitted and infringes, amongst others, our registered trademark rights. Such modifications may affect technical properties of our products, damage them and possibly cause consequential damage to other objects. The manufacturer shall not be responsible under any circumstances for damage caused by such modifications.



Bei Fragen zu unseren Symbolen, besuchen Sie folgende Webseite:  
 If you have any questions about our signs, visit the following website:







[https://www.rzb.de/fileadmin/assets/downloads/PDF/RZB\\_Symbolklaerung.pdf](https://www.rzb.de/fileadmin/assets/downloads/PDF/RZB_Symbolklaerung.pdf)

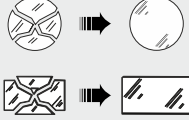

**EEK** 



Dieses Produkt enthält eine Lichtquelle der Energieeffizienzklasse D entsprechend Verordnung (EU) 2019/2015

This product contains a light source of energy efficiency class D according to regulation (EU) No 2019/2015

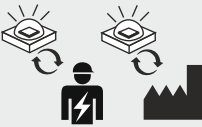
 →  Jede zersprungene Schutzabdeckung ist zu ersetzen. DIN EN 60598

 →  Replace any cracked protective shield. IEC DIN EN 60598

  Die Lichtquelle dieser Leuchte darf nur vom Hersteller oder einem von ihm beauftragten Servicetechniker oder einer vergleichbar qualifizierten Person ersetzt werden. DIN EN 60598-1 / IEC 60598-1

  The light source contained in this luminaire shall only be replaced by the manufacturer or his service agent or a similar qualified person. DIN EN 60598-1 / IEC 60598-1



IP 40



IP 65

**a**

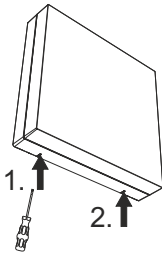

öffnen  
to open

**b**

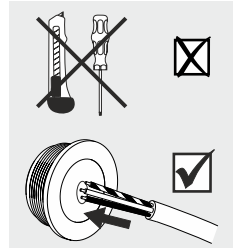

**c**

Dieser Bereich darf eingestellt werden!

Konvertereinstellungen:

This range may be set!

Converter settings:

I <sub>out</sub>	V <sub>omin</sub>	1	2	3	4	
300 mA	15 V	-	-	-	-	
350 mA	15 V	-	-	-	on	
400 mA	13 V	-	-	on	-	1300lm, 3000K
450 mA	11 V	-	-	on	on	1400lm, 4000K
500 mA	10 V	-	on	-	-	
550 mA	9 V	-	on	-	on	
600 mA	8 V	-	on	on	-	
650 mA	8 V	-	on	on	on	2150lm, 3000K
700 mA	7 V	on	-	-	-	2300lm, 4000K
750 mA	6 V	on	-	-	on	

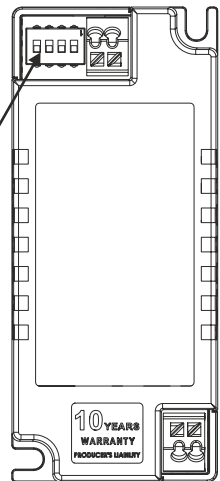

d

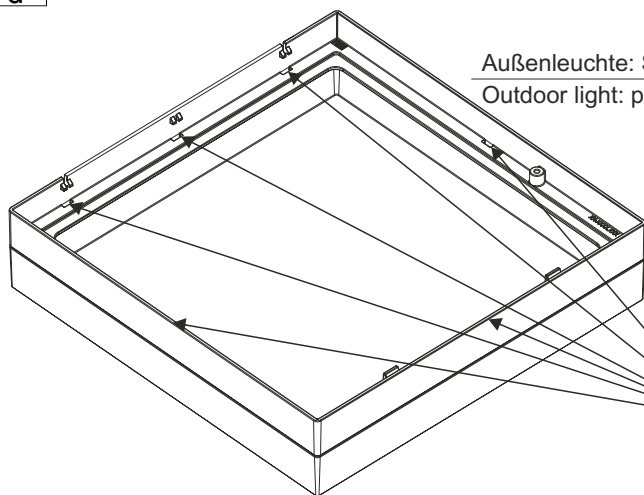

Außenleuchte: Stöpsel müssen entfernt werden!  
Outdoor light: plugs must be removed!

6x ■



e



## HYTRONIK®

HYTRONIK INDUSTRIAL LIMITED  
Room D, 10/E, Tower A, Billion Center, 1 wang Kwang Road,  
Kowloon Bay, Kowloon, Hongkong  
T: 00852-35197525 F: 00852-30114936  
E: info@hytronik.com

CHINA FACTORY  
Pude Industrial Park, Dushi Village, Pingtan Town  
Huiyang District Huizhou City Guangdong, P.R.C. 514259  
T: 86-752-2772020 F: 86-752-2777877  
E: info@hytronik.com W: www.hytronik.com

## Declaration of Conformity

We, Hytronik Electronics Co., Ltd

No.1 plant ,Tangbeyuan village group, Dushi Village, Pingtan Town, Huiyang District, Huizhou , Guangdong ,China. Declare at our sole responsibility, that the devices as following are designed and manufactured is in conformity with the Provisions of the following EU Directive(s) and that the standards and /or technical specifications referenced.

Brand:	Hytronik
Product models:	HC007S
Type:	Motion sensor
Relevant EU directives:	2014/53/EU; 2011/65/EU(With amendment EU 2015/863);
Standards complied	EN 60669-1:2018 EN 60669-2-1:2004/A12:2010 EN 55015:2019/A11:2020 EN 61547:2009 EN IEC61000-3-2:2019/A11:2021 EN 61000-3-3:2013/A2:2021 EN 300 440 V 2.2.1 EN 301489-1 V2.2.3 EN 301489-3 V2.2.0 EN 50663:2017

We declare as the manufacturer that the mentioned above complies with all essential requirements in the way specified and conforms with the type for which is above mentioned, and be affixed the CE-mark on the product or to the packaging and any accompanying documentation.

Sep.30th,2022

(place and date of issue)



*Simon Xia*

(Test Dep. Manager)( Simon Xia)

f

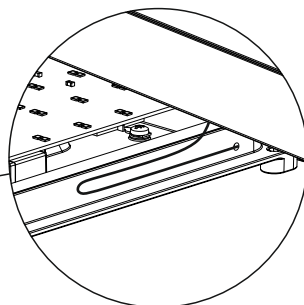
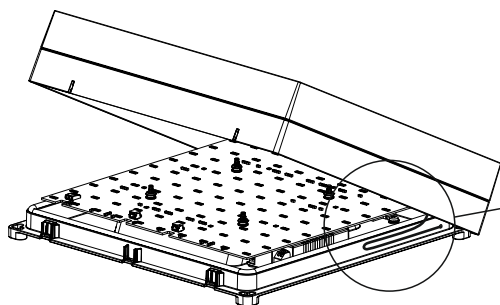
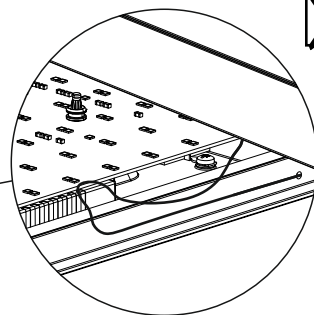
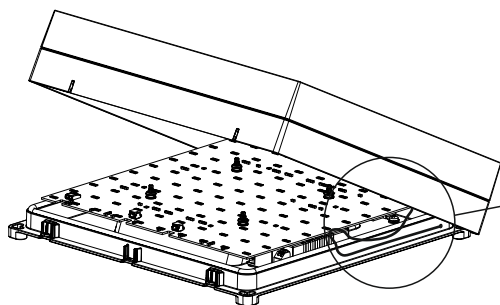

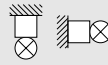

1 **Wandmontage**  
**Wall mounting**

2

öffnen  
to open

3

4

5

6

7

N ⊖ L

8

4x ● Druckbereich  
Push area

9

4000K 3000K

10



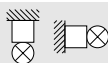

11

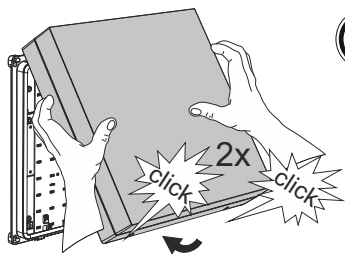

12

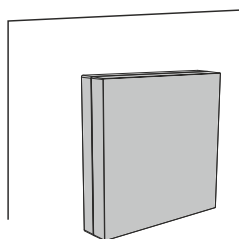

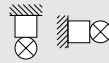

1 Deckenmontage  
Ceiling mounting

2

öffnen  
to open

3

4

5

6

7

4x

8

N ⊕ L

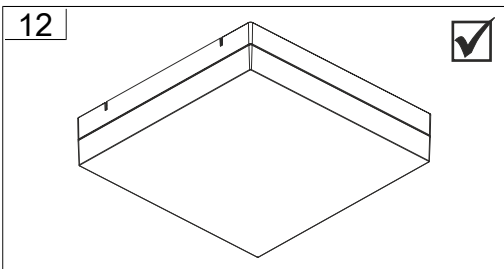
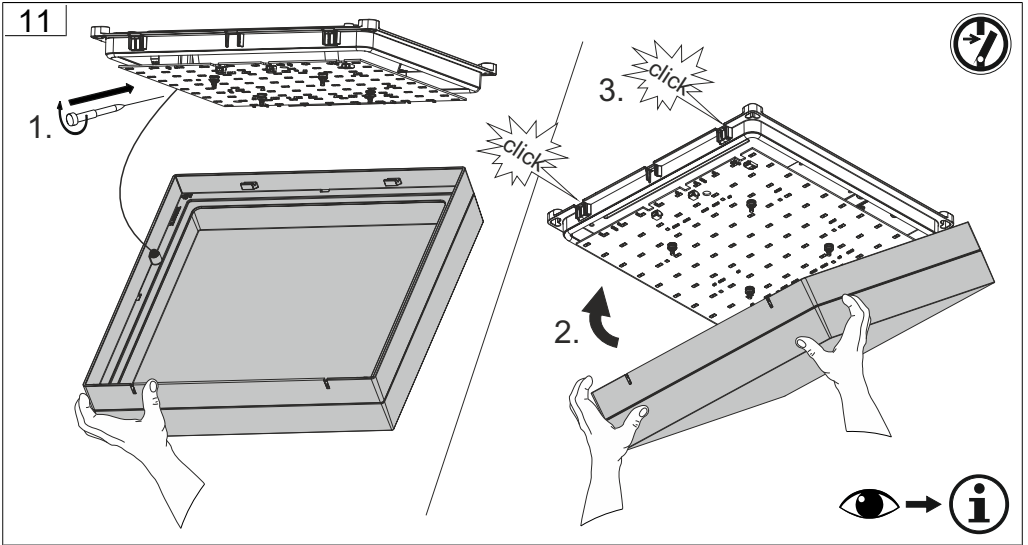
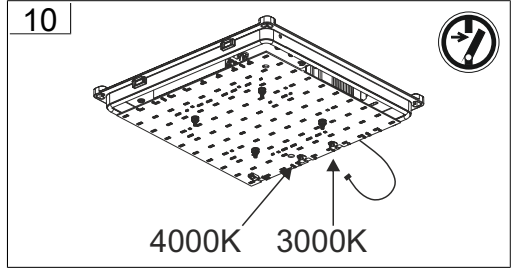
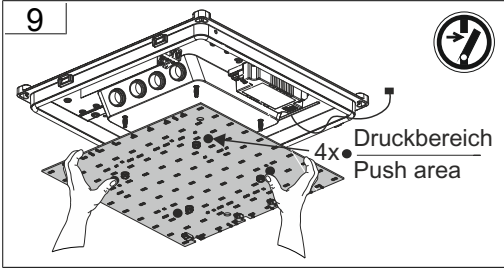
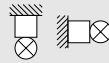



1

öffnen  
to open

2

3

4

5

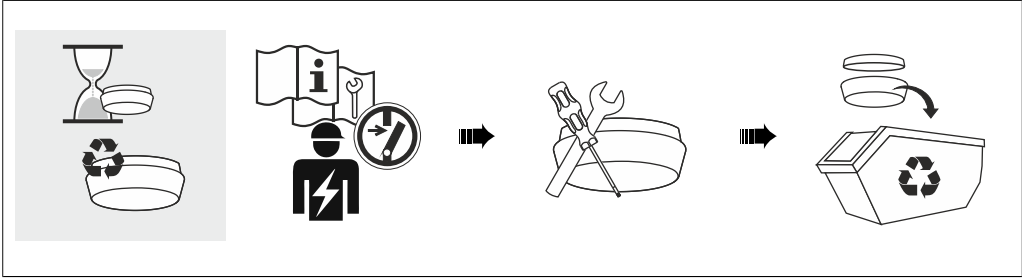
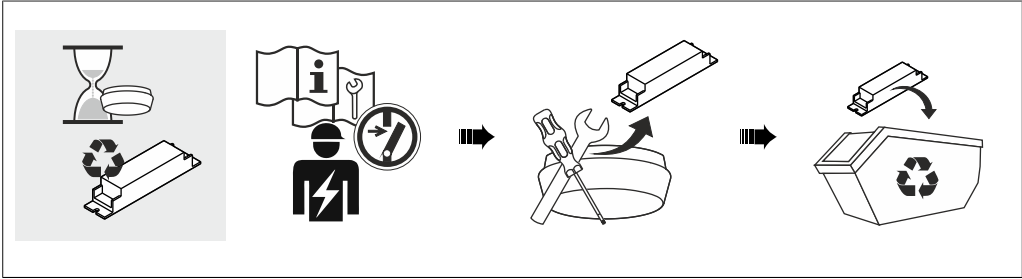
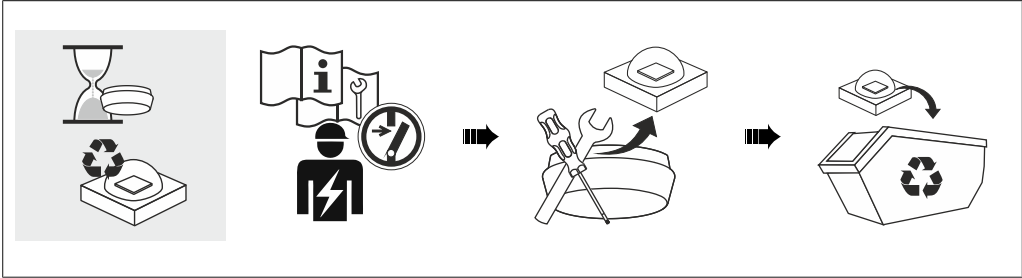

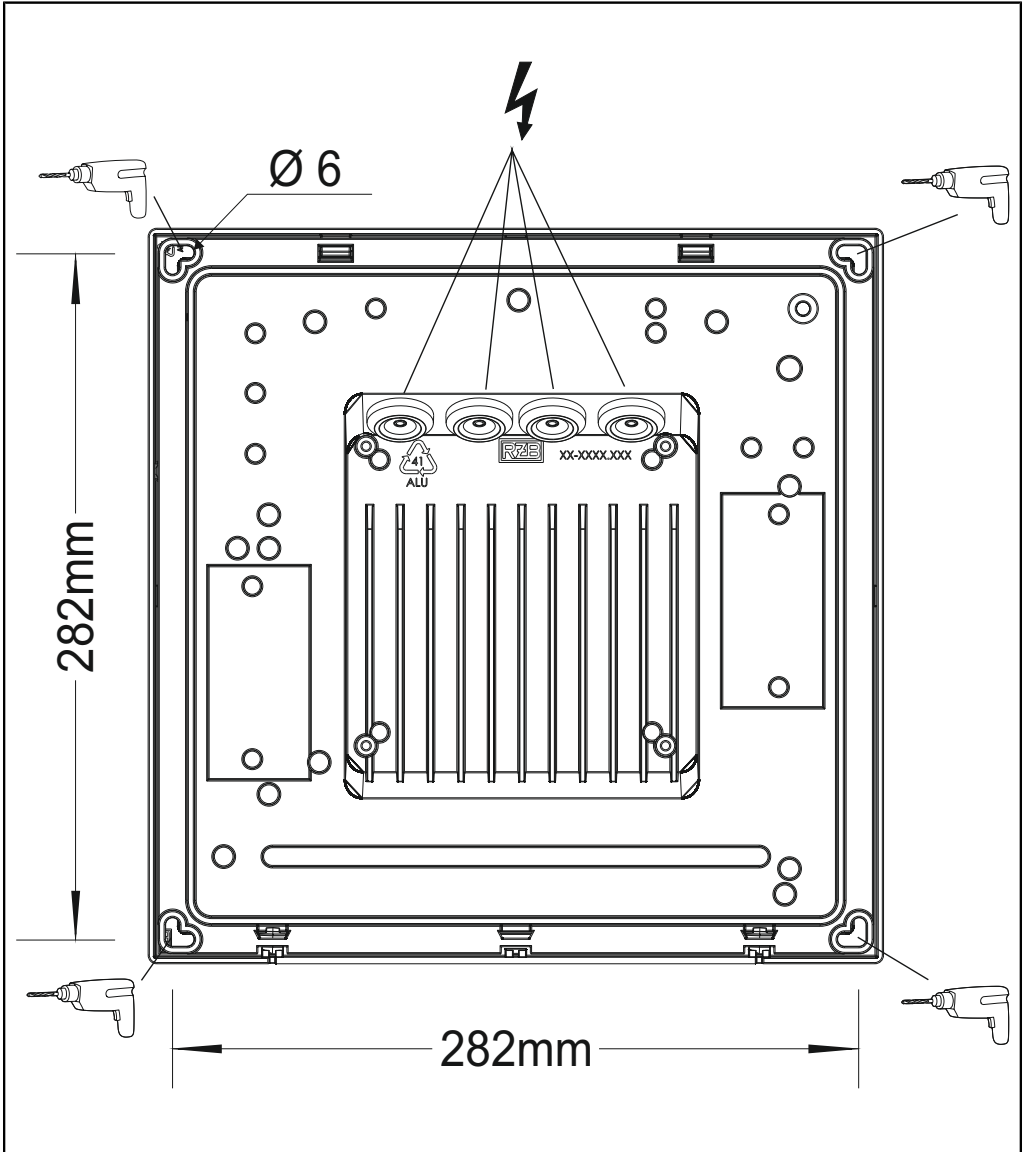

RZB - Rudolf Zimmermann, Bamberg GmbH

🏠 Rheinstraße 16, 96052 Bamberg

☎ 0951/7909-0

📠 0951/7909-198

🌐 [info@rzb-leuchten.de](mailto:info@rzb-leuchten.de)