

INSTRUCTION

Planado
672620.002.04

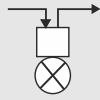

≈ 220 - 240 V 0/50/60 Hz IP 50, IP 50

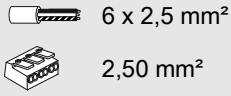

Dauerschaltung / maintained
=> 0 °C ... + 35 °C
Bereitschaftsschaltung / non
maintained
=> 5 °C ... + 40 °C

8 h
LiFePo4
3,2 V - 1,5 Ah



L 320, B 160, H 58



1,5 kg

	Φ_{H} [lm]	P_{H} [W]	Φ_{H} [lm]	P_{H}
--	------------------------	--------------------	------------------------	----------------

LED 90 3,1 10 1 x 2,2 W

CCT [K]	CRI	[m]	RG
---------	-----	-----	----

4000 80 30 RG 1

I_{max} $I_{\text{max}}/2$	B_{10} [St.]	B_{16} [St.]	C_{10} [St.]	C_{16} [St.]
-------------------------------------	----------------	----------------	----------------	----------------

0,12 A / 5000 μ s 30 40 30 40

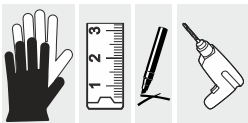



Allgemeine Sicherheitshinweise

- Der elektrische Anschluss muss ordnungsgemäß nach geltenden Normen und den nationalen sowie internationalen Sicherheits- und Unfallverhütungsvorschriften erfolgen.
- Beschädigte Leuchten dürfen nicht betrieben werden.
- Keine Haftung für Schäden durch unsachgemäßen Einsatz.
- Bei Instandsetzung nur Originalteile verwenden.
- Tragfähigkeit der Decke und Befestigungselemente sicherstellen.

Betrieb der Leuchte

- Die unzulässigen Umgebungstemperaturen reduzieren die Lebensdauer der Leuchte, im Extremfall droht der Frühausfall.
- Zur Vermeidung von EMV-Problemen die Durchgangsverdrahtung nicht entlang der Leuchtenverdrahtung führen.
- Steuereingänge von dimmbaren Leuchten mit handelsüblichen für Netzspannung geeigneten Leitungen anschließen.

Manipulationen unserer Produkte sind unzulässig

Veränderung, Umarbeitung, Umkennzeichnung von Produkten sowie deren Verpackung sind unzulässig und verletzen u.a. unsere eingetragenen Warenzeichenrechte. Solche Modifikationen können technische Eigenschaften unserer Produkte negativ beeinflussen, diese zerstören und möglicherweise Folgeschäden an anderen Objekten verursachen. Für durch derartige Modifikationen verursachte Schäden kann der Hersteller in keinem Fall verantwortlich gemacht werden.



General Safety Information

- Electric connection must be appropriate according to all applicable standards and other national and international safety and accident prevention regulations.
- Damaged luminaires must not be operated.
- No liability is accepted for damages resulting from improper use.
- Use genuine parts only for repair.
- Ensure stability of the ceiling and fastening elements.

Operation of the luminaire

- Exceeding the permissible ambient temperature will reduce the luminaire's lifecycle, resulting in premature failure in extreme cases.
- Avoid ESD problems by not routing feed-through wiring directly along the wiring of the luminaire.
- Connect control inputs of dimmable luminaires with standard cables suitable for power supply voltage.

Manipulation of our products is not permitted

Modifications, reworking, re-labelling of products as well as their package is not permitted and infringes, amongst others, our registered trademark rights. Such modifications may affect technical properties of our products, damage them and possibly cause consequential damage to other objects. The manufacturer shall not be responsible under any circumstances for damage caused by such modifications.



Bei Fragen zu unseren Symbolen, besuchen Sie folgende Webseite:
If you have any questions about our signs, visit the following website:

https://www.rzb.de/fileadmin/assets/downloads/PDF/RZB_Symbolklaerung.pdf

Jede zersprungene Schutzabdeckung ist zu ersetzen. DIN EN 60598
Replace any cracked protective shield. IEC DIN EN 60598

Die Lichtquelle dieser Leuchte darf nur vom Hersteller oder einem von ihm beauftragten Servicetechniker oder einer vergleichbar qualifizierten Person ersetzt werden. DIN EN 60598-1 / IEC 60598-1
The light source contained in this luminaire shall only be replaced by the manufacturer or his service agent or a similar qualified person. DIN EN 60598-1 / IEC 60598-1

Zur Verwendung in Anlagen nach EN 50172 / DIN VDE 0108-100
For installation according to EN-50172 / DIN VDE 0108-100



Die Sicherheitsleuchten werden generell mit entladenen oder teilentladenen Akkus ausgeliefert und müssen für die volle Funktionstüchtigkeit die vorgegebene Inbetriebnahme durchlaufen.

The emergency luminaires are delivered with either discharged or only partially charged batteries and run through the specified commissioning before reaching their fully operability.



Einteilung Notleuchten

*	**	***	****
---	----	-----	------

Veränderungen am Auslieferungszustand der Leuchte sind gemäß DIN EN 60598-2-22 auf dem Typenschild zu kennzeichnen.

Classification Emergency Lighting

*	**	***	****
---	----	-----	------

Modifications to the delivery condition of the luminaire must be documented on the product label accordingly to IEC 60598-2-22.

*	Typ (1-stellig)	Type (1-digit)
X	Einzelbatterie	Self-Contained
Z	Zentralbatterie	Central Supply

**	Betriebsart (1-stellig)	Operating Mode (1-digit)
0	Notleuchte Bereitschaftsschaltung	Emergency Lighting non-maintained
1	Notleuchte Dauerschaltung	Emergency Lighting maintained
2	Kombinierte Notleuchte Bereitschaftssch.	Combi. Emergency Lighting non-maintained
3	Kombinierte Notleuchte Dauerschaltung	Combined Emergency Lighting maintained

***	Einrichtungen (max. 7-stellig)	Installation (max. 7-digit)
A	manuelle Prüfeinrichtung	Manual Test Device
B	Fernschalter für Ruhe-Zustand	Including Remote Rest Mode
C	Fernausschaltemöglichkeit	Including Inhibiting Mode
D	Arbeitsstätten m. besonderer Gefährdung	High-Risk Task-Area Luminaire
E	Lampe oder Batterie nicht austauschbar	With non-replaceable Lamps or Battery
F	automatische Prüfeinrichtung	Automatic Test Device
G	von innen beleuchtetes Sicherheitszeich.	Inside illuminated safety sign

****	Betriebsdauer (2/3-stellig) (nur bei Einzelbatterie)	Duration Time (2/3-digit) (only for self-contained)
60	Betriebsdauer 60 Minuten	Duration Time 60 Minutes
180	Betriebsdauer 180 Minuten	Duration Time 180 Minutes
480	Betriebsdauer 480 Minuten	Duration Time 480 Minutes



Anschlussplan / Wiring diagram

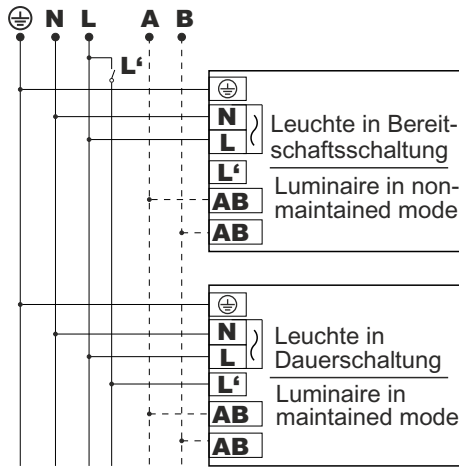

⊕	<u>Schutzleiter (SK I)</u> Ground Wire (PC I)	
	N	<u>Nullleiter</u> Neutral Wire
L		<u>Dauerphase</u> Duration Wire
	L'	<u>Geschaltete Phase für Dauerschaltung</u> Connected phase for maintained operation
Multidigit .04		<u>Kennzeichnung</u> Marking
	<u>Standardsignal</u> Standard signal	< 36V
	<u>BUS-Leitungen können vertauscht werden!</u> Connection wires may be interchanged!	

Funktionsanzeige LED / Indicator LED

	intermittierend grün (8s) intermittently green (8s)	Akku Regenerierung battery regeneration
	permanent grün permanently green	keine Störung no fault
	permanent rot blinkend continuously flashing red	Fehler Akku battery fault
	intermittierend rot blinkend intermittently flashing red	Fehler Leuchtmittel luminaire fault
	dunkel dark	Notbetrieb / kein Netz emergency operation / no mains

Kontrolle nach der Installation

30 Minuten nach der Inbetriebnahme muss die Status-LED grün leuchten. Wenn die LED nicht leuchtet, ist die Ladung durch fehlende Netzspannung, unterbrochene Leitung zum Akku oder defekte Ladeeinheit nicht gewährleistet.

Optimierung der Lebensdauer des Akkus

Bei jeder Inbetriebnahme bzw. jedem Akkuwechsel wird ein Regenerierungsverfahren ausgeführt. Das Verfahren dauert ca. 3 - 4 Tage. Erst danach ist die Leuchte uneingeschränkt einsatzbereit.

Dauertests

Der erste Dauertest erfolgt ca. 8 Tage nach dem Regenerierungsverfahren. Dieser wird alle 12 Wochen durchgeführt, um die Lebensdauer der Akkus zu optimieren.

Prüfungen

Einzelbatterieleuchten sind gemäß der Vorschriften am Montageort zu testen. Mängel sind sofort zu beheben. Prüfergebnisse sind im Prüfbuch zu dokumentieren.

Quittieren

Wenn beim Test Fehler auftreten, werden diese durch die farbige Status LED an der Leuchte angezeigt. Um die Fehleranzeige nach Behebung des Fehlers zurückzusetzen, muss die Versorgungsspannung der Leuchte kurzfristig abgeschaltet werden.

Check after installation

30 minutes after start up must the green LED on. If the LED is off, it must be detected that the charging is not inhibited due to a missing voltage supply, due to a lineinterruption to the battery or due to a faulty electronic.

Optimizing the lifetime of the battery

With every start up or battery change a regeneration process will be performed. The process takes a time of 3 until 4 days. After that the luminaire is absolutely ready for use.

Endurance test

The first duration test occurs after 8 days after the regeneration process. This one will carried out every 12 weeks, to optimize the battery life.

Tests

Self-contained luminaires had to tested at their mounting location in compliance with the regulations. Any defects have to be repaired immediately. Test results need to noted.

Acknowledging error status

If failure will displayed, these are indicated by colored status LED on luminaire. Reset the error status after testing, the luminaire has to be disconnected from mains voltage temporarily.



Hinweise zum Aufbringen der Folien

How to apply the legend to the cover

- | | | |
|----|--|--|
| ! | | <u>Folie bei Raumtemperatur aufkleben</u>
Affix the foil at room temperature |
| 1. | | <u>Oberfläche säubern (fett- und staubfrei)</u>
Clean the surface (it must be free from dust and grease) |
| 2. | | <u>Schutzpapier (bedruckte Seite) von Klebeseite der Folie abziehen</u>
Remove the protective paper (printed side) from the self adhesive legend |
| 3. | | <u>Folie in entspanntes Wasser tauchen (z.B. Wasser mit Spülmittel)</u>
Soak the self-adhesive legend in mild washing-up liquid water |
| 4. | | <u>Klebefolie auf die Abdeckung auflegen und ausrichten</u>
Apply the self-adhesive legend to the diffuser properly |
| 5. | | <u>Mit einem Raket oder der Hand alle Luft- und Wassereinschlüsse zwischen Folie und Abdeckung zu den Seiten hinwegstreichen</u>
Flatten the legend ad sweep away all air and watterbubbles between the foil and the diffusor by hand or with a spreading knife |
| 6. | | <u>Übertragungspapier, falls vorhanden, vorsichtig abziehen</u>
Remove carefully transfer paper if there is one |
| 7. | | <u>ACHTUNG: Abdeckungen nur mit abgetrockneter Folie montieren!</u>
<u>WARNING: Only a diffuser with a dried legend must be attached to the fitting!</u> |

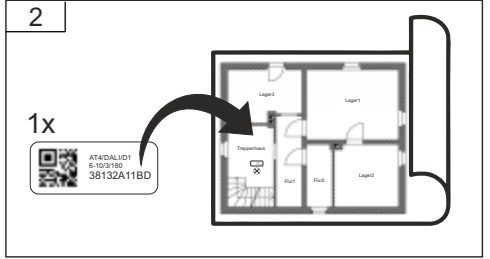
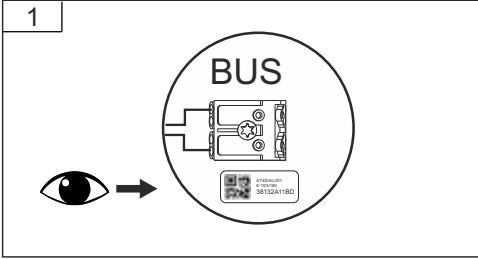

3

		<p>AT4DALID1 6-10/3/180 38132A11BD</p>
		<p>AT4DALID1 6-10/3/180 38132A11BD</p>

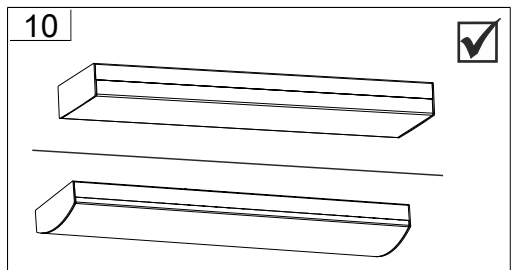
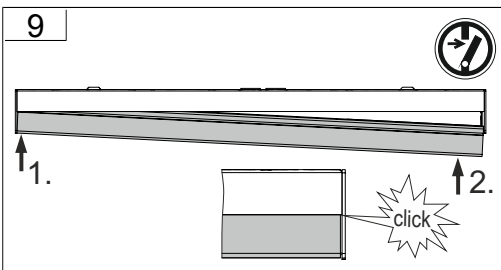
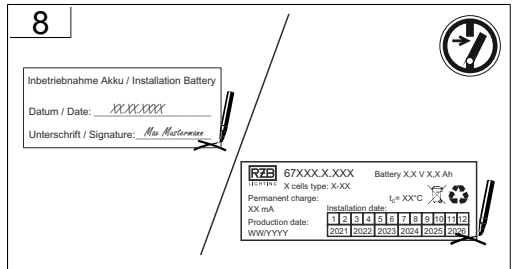
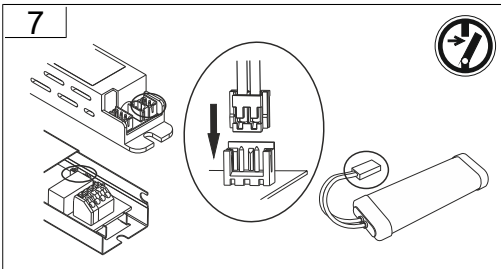
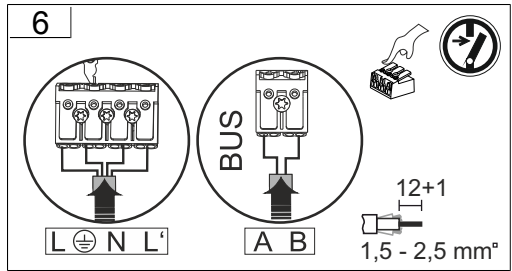
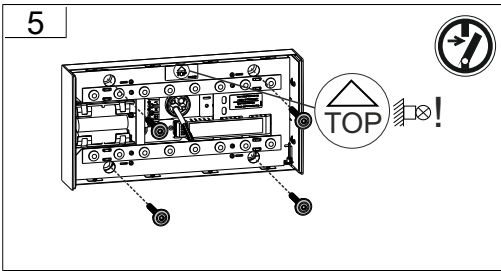
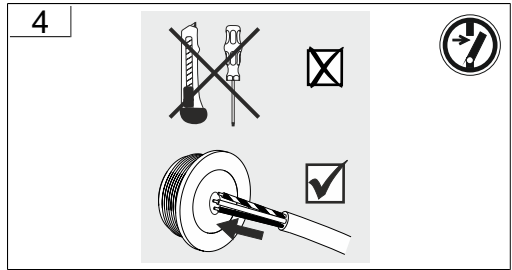
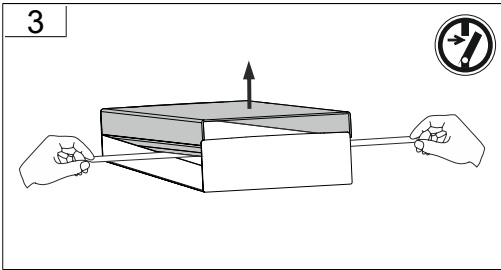
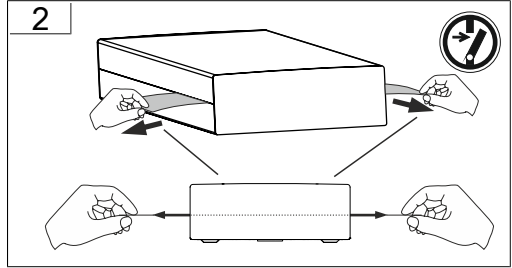
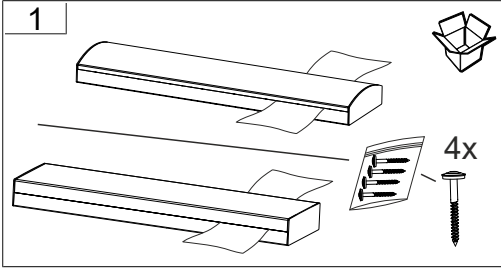

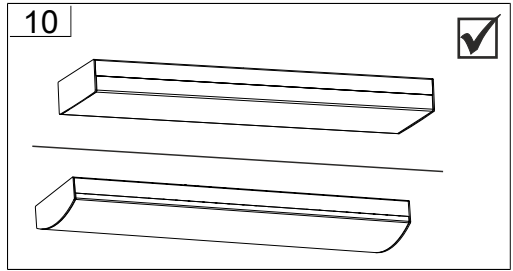
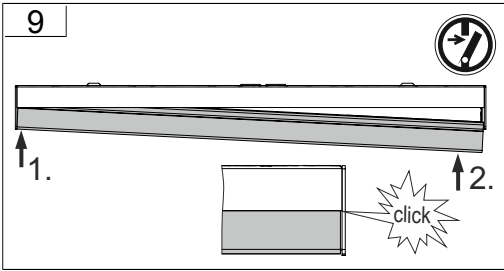
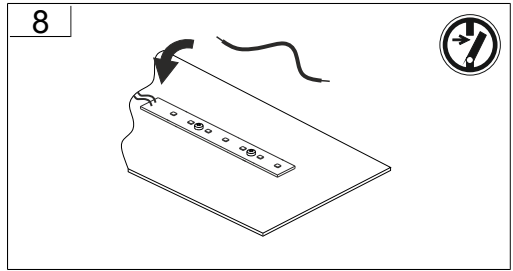
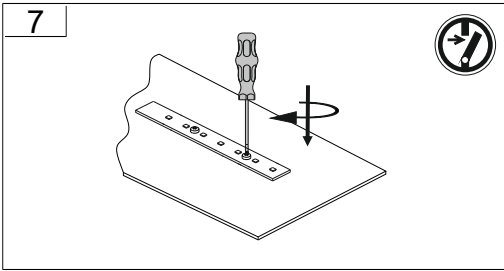
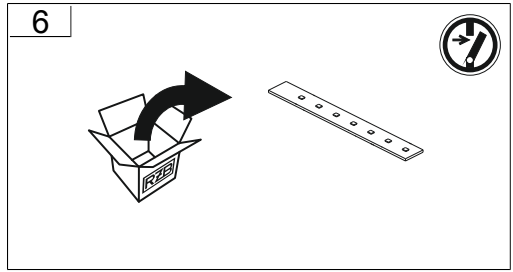
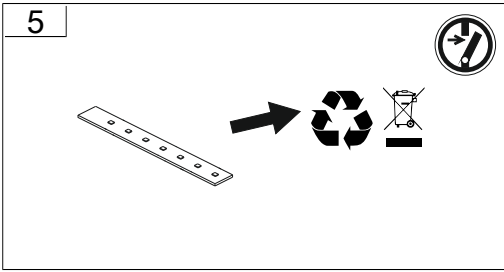
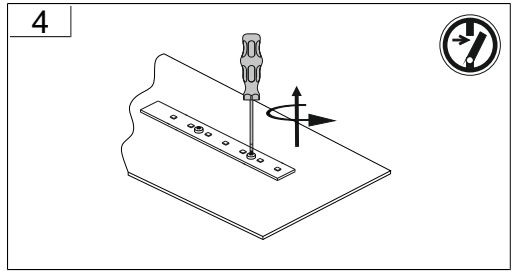
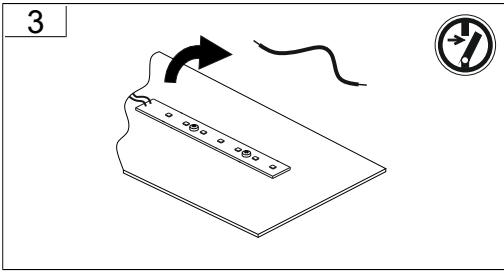
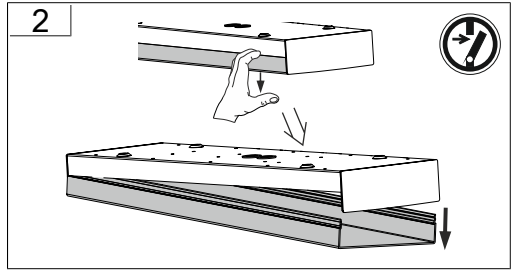
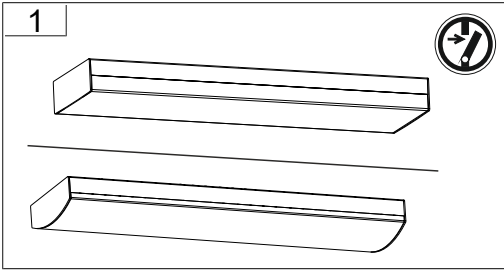

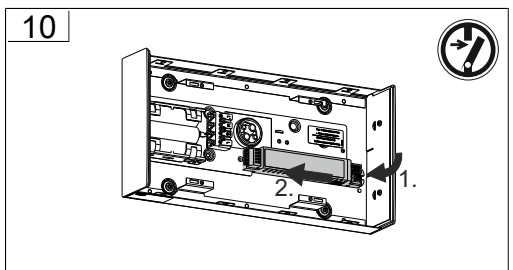
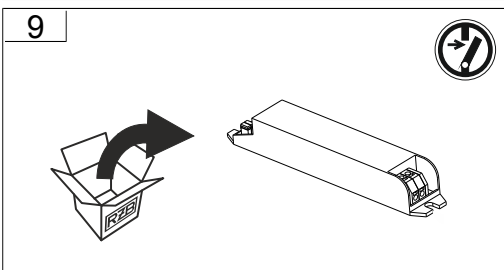
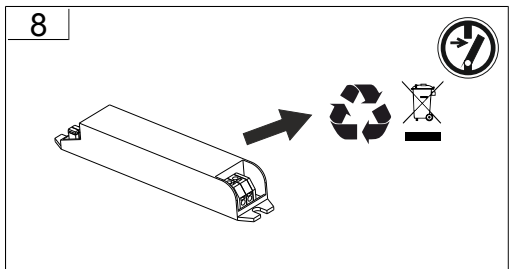
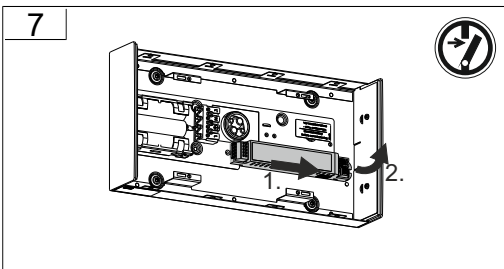
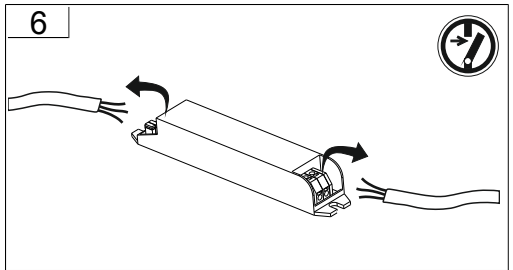
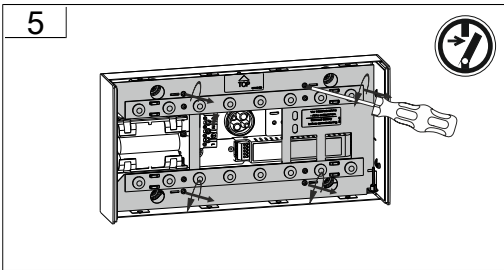
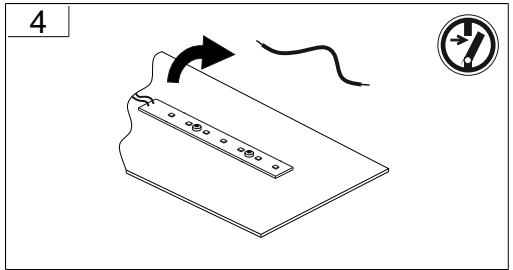
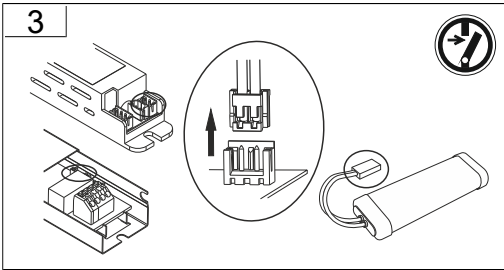
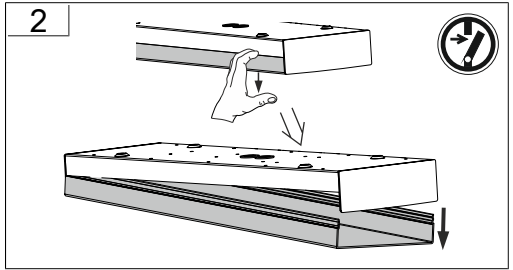
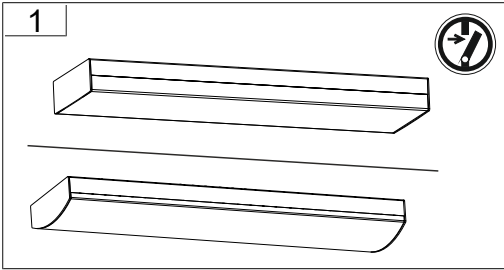

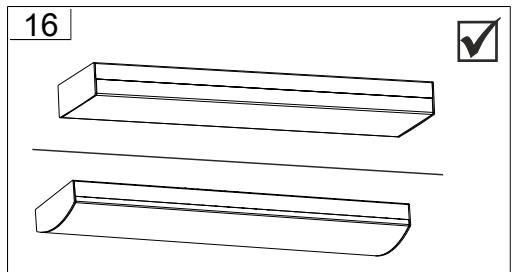
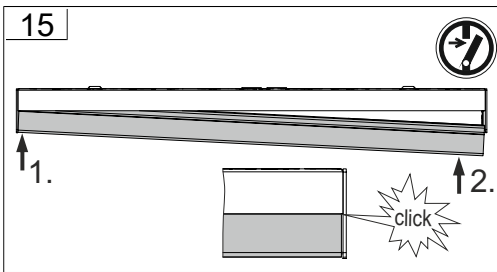
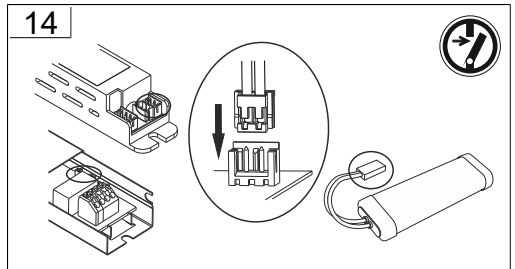
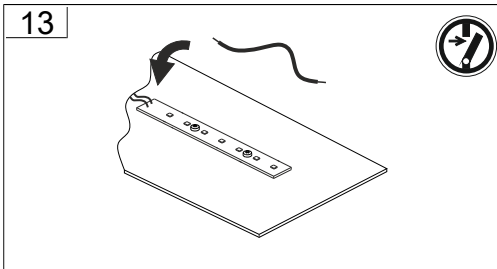
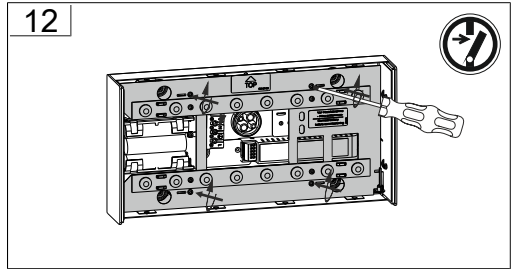
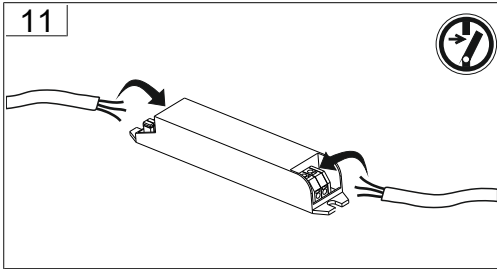

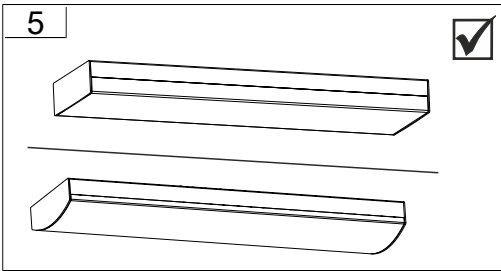
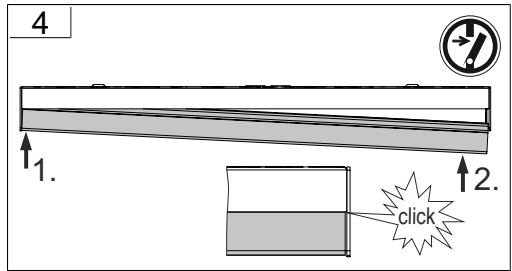
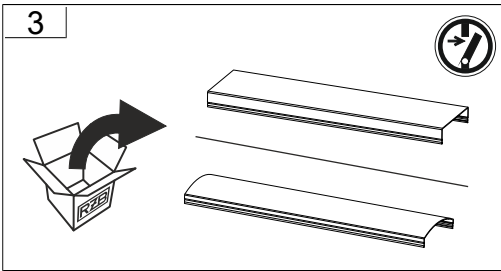
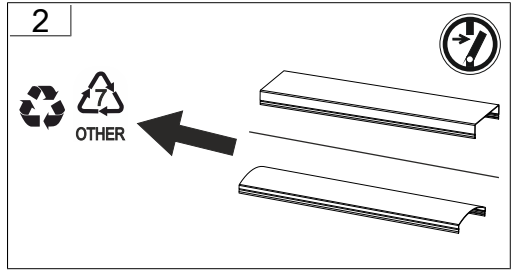
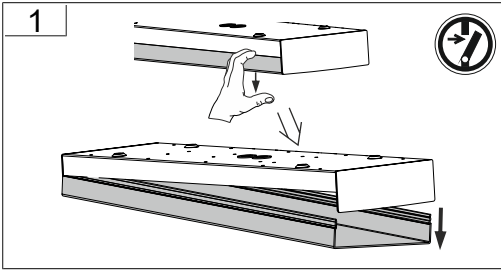

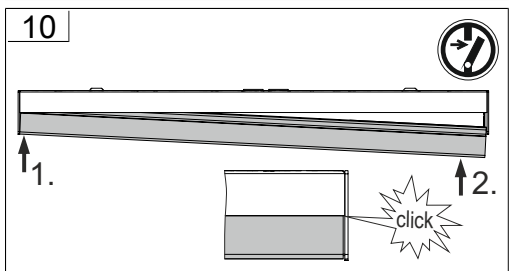
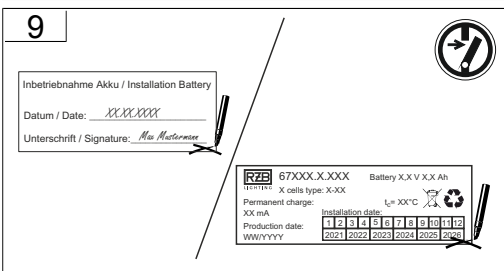
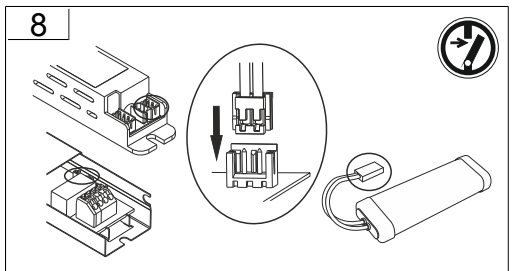
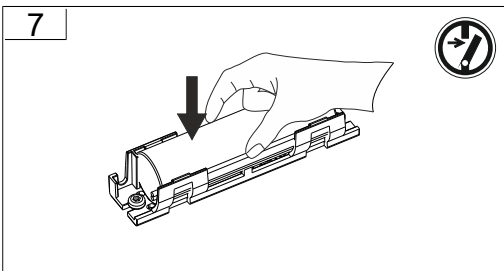
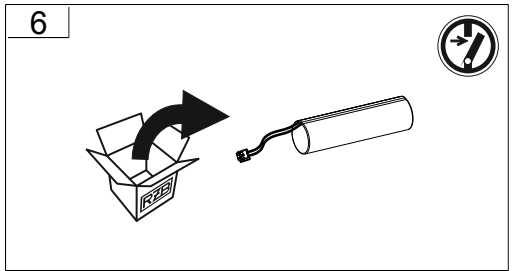
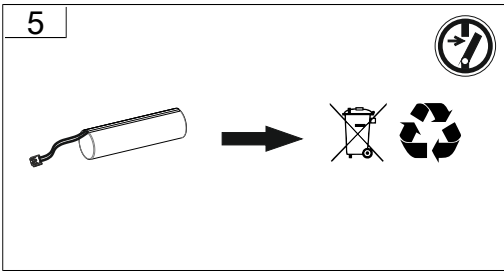
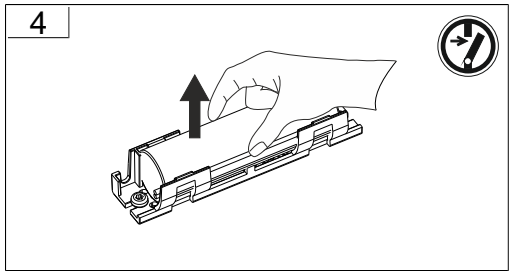
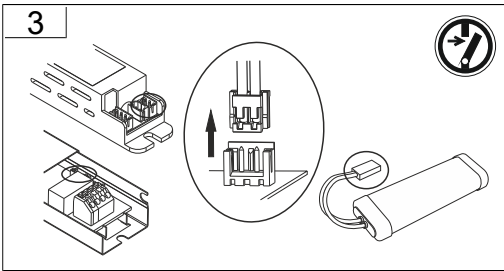
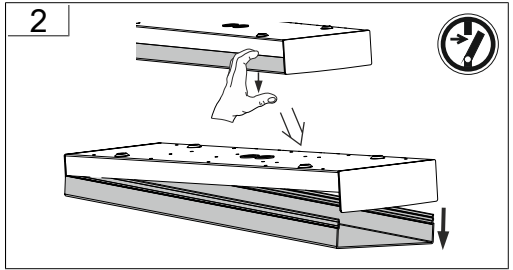
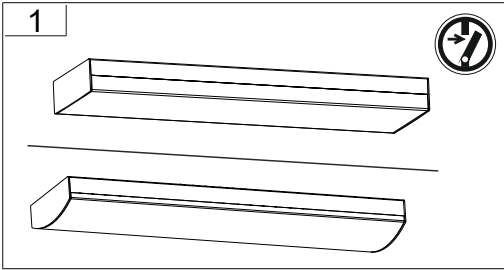
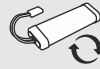

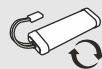

11



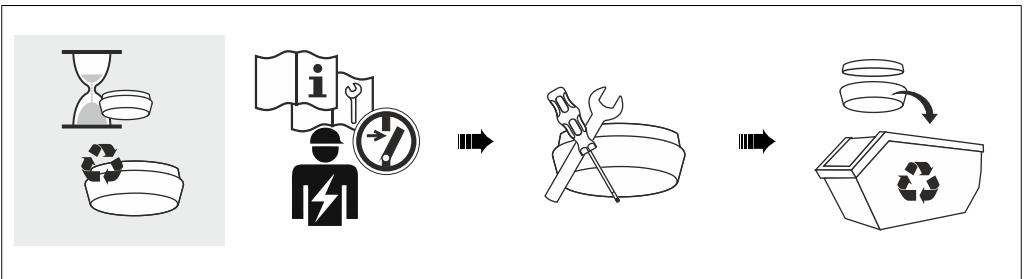
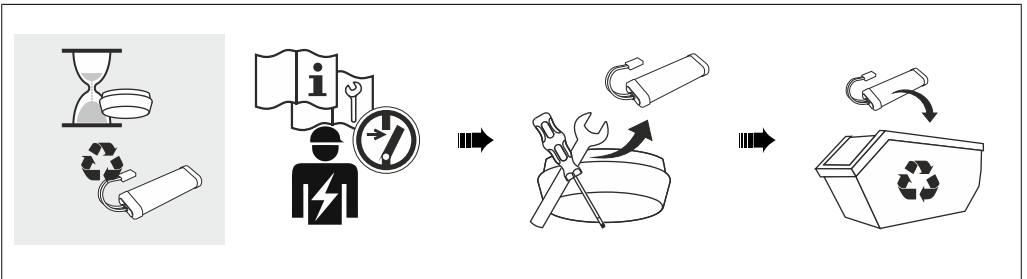
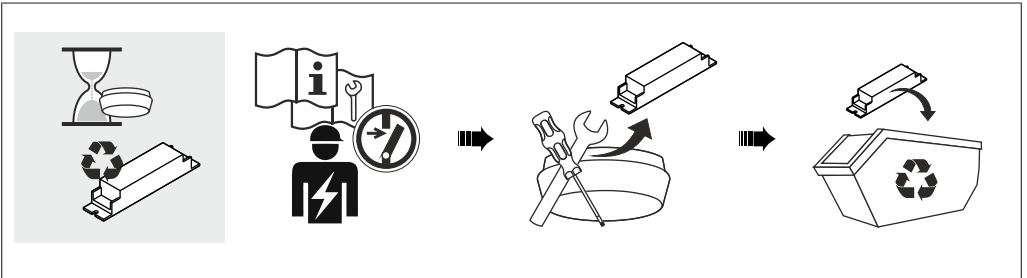
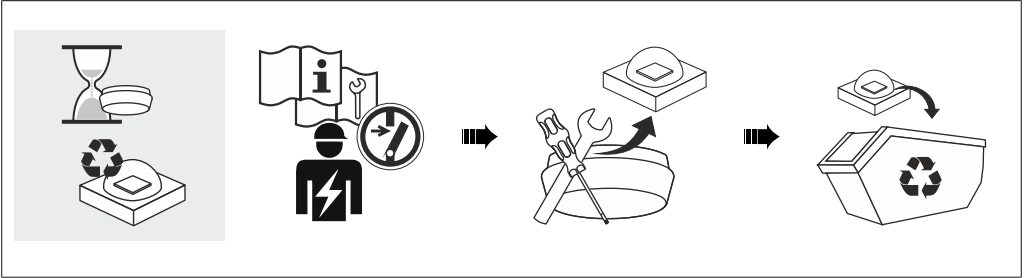





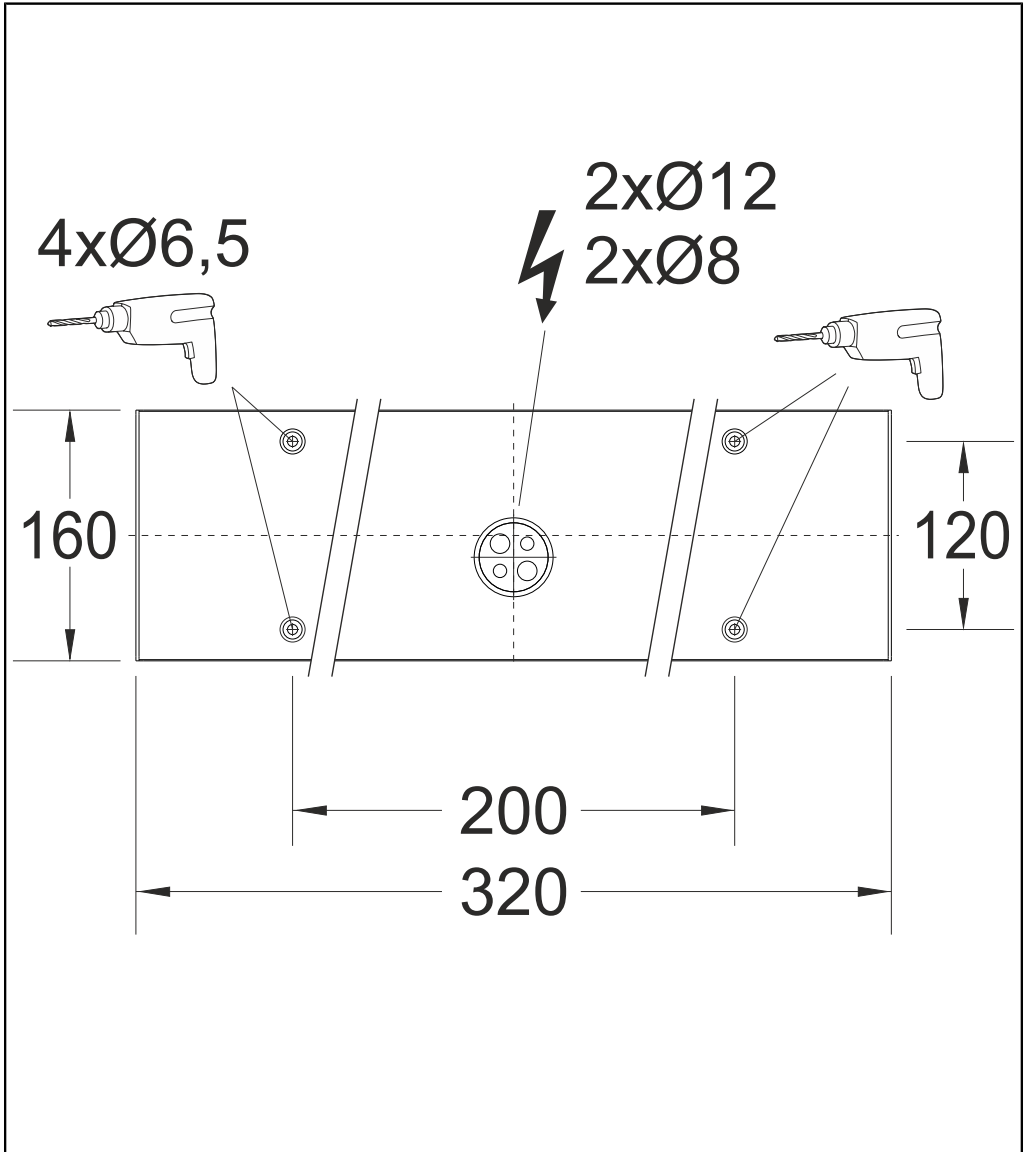

RZB - Rudolf Zimmermann, Bamberg GmbH

🏠 Rheinstraße 16, 96052 Bamberg

☎ 0951/7909-0

📠 0951/7909-198

🌐 info@rzb-leuchten.de