

# INSTRUCTION

TX-Move  
901854.002.1



~ 220 - 240 V 50/60 Hz IP 20, IP 20 IK03



 3 x 1,5 mm<sup>2</sup>



Umgebungstemperatur /  
temperature ambiente  
=> 5 °C ... + 25 °C

 1,50 mm<sup>2</sup>

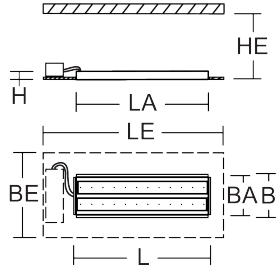

L 622, B 190, H 39



LA 602, BA 174,  
HE 100, LE 700, BE 390



2,65 kg



LED

$\Phi_{\text{lm}}$  [lm]

7450

$P_{\text{lm}}$  [W]

47

$P_{\text{lm}}$

2 x 19,4 W

CCT [K]

4000

CRI

80

RG  $\text{\textcircled{R}}$

RG 1

EEK  $\text{\textcircled{E}}$

C

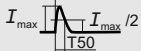

9 A / 65  $\mu$ s



10



17



17



28

$\text{COS } \varphi$

0,9



LG 240, BG 88, HG 46

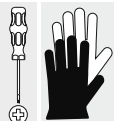



Installation erfordert  
Elektro-Fachkraft!

Symbole nach ISO 7010



### Allgemeine Sicherheitshinweise

- Der elektrische Anschluss muss ordnungsgemäß nach geltenden Normen und den nationalen sowie internationalen Sicherheits- und Unfallverhütungsvorschriften erfolgen.
- Beschädigte Leuchten dürfen nicht betrieben werden.
- Keine Haftung für Schäden durch unsachgemäßen Einsatz.
- Bei Instandsetzung nur Originalteile verwenden.
- Tragfähigkeit der Decke und Befestigungselemente sicherstellen.

### Betrieb der Leuchte

- Die unzulässigen Umgebungstemperaturen reduzieren die Lebensdauer der Leuchte, im Extremfall droht der Frühausfall.
- Zur Vermeidung von EMV-Problemen die Durchgangsverdrahtung nicht entlang der Leuchtenverdrahtung führen.
- Steuereingänge von dimmbaren Leuchten mit handelsüblichen für Netzspannung geeigneten Leitungen anschließen.

### Manipulationen unserer Produkte sind unzulässig

Veränderung, Umarbeitung, Umkennzeichnung von Produkten sowie deren Verpackung sind unzulässig und verletzen u.a. unsere eingetragenen Warenzeichenrechte. Solche Modifikationen können technische Eigenschaften unserer Produkte negativ beeinflussen, diese zerstören und möglicherweise Folgeschäden an anderen Objekten verursachen. Für durch derartige Modifikationen verursachte Schäden kann der Hersteller in keinem Fall verantwortlich gemacht werden.



Installation requires  
a qualified electrician!

Symbols according  
to ISO 7010



### General Safety Information

- Electric connection must be appropriate according to all applicable standards and other national and international safety and accident prevention regulations.
- Damaged luminaires must not be operated.
- No liability is accepted for damages resulting from improper use.
- Use genuine parts only for repair.
- Ensure stability of the ceiling and fastening elements.

### Operation of the luminaire

- Exceeding the permissible ambient temperature will reduce the luminaire's lifecycle, resulting in premature failure in extreme cases.
- Avoid ESD problems by not routing feed-through wiring directly along the wiring of the luminaire.
- Connect control inputs of dimmable luminaires with standard cables suitable for power supply voltage.

### Manipulation of our products is not permitted

Modifications, reworking, re-labelling of products as well as their package is not permitted and infringes, amongst others, our registered trademark rights. Such modifications may affect technical properties of our products, damage them and possibly cause consequential damage to other objects. The manufacturer shall not be responsible under any circumstances for damage caused by such modifications.

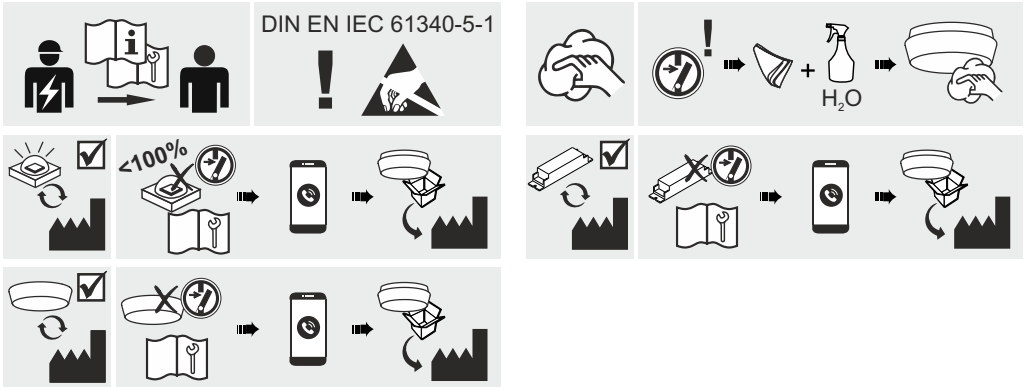

Bei Fragen zu unseren Symbolen, besuchen Sie folgende Webseite:

If you have any questions about our signs, visit the following website:



[https://www.rzb.de/fileadmin/assets/downloads/PDF/RZB\\_Symbolklaerung.pdf](https://www.rzb.de/fileadmin/assets/downloads/PDF/RZB_Symbolklaerung.pdf)

**EEK**

Dieses Produkt enthält eine Lichtquelle der Energieeffizienzklasse C  
entsprechend Verordnung (EU) 2019/2015

This product contains a light source of energy efficiency class C  
according to regulation (EU) No 2019/2015

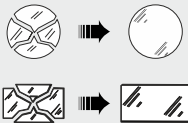

Jede zersprungene Schutzabdeckung ist zu ersetzen. DIN EN 60598

Replace any cracked protective shield. IEC DIN EN 60598



Die Lichtquelle dieser Leuchte darf nur vom Hersteller oder einem  
von ihm beauftragten Servicetechniker oder einer vergleichbar  
qualifizierten Person ersetzt werden. DIN EN 60598-1 / IEC 60598-1

The light source contained in this luminaire shall only be  
replaced by the manufacturer or his service agent or a similar  
qualified person. DIN EN 60598-1 / IEC 60598-1

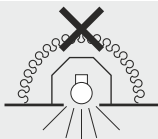

Nicht zur Abdeckung mit Wärmedämm-Material geeignete Leuchten!

Not to be covered with thermal insulation material!

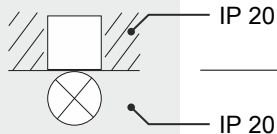



ON/OFF DALI		CCT 3000 K							CCT 4000 K								
1	2	3	4	⚙️ [mA]	P <sub>g</sub> [W]	Φ <sub>g</sub> 30° [lm]	Φ <sub>g</sub> 60° [lm]	Φ <sub>g</sub> 90° [lm]	Φ <sub>g</sub> AS [lm]	Φ <sub>g</sub> OFF [lm]	Φ <sub>g</sub> 30° [lm]	Φ <sub>g</sub> 60° [lm]	Φ <sub>g</sub> 90° [lm]	Φ <sub>g</sub> AS [lm]	Φ <sub>g</sub> OFF [lm]		
1	ON	1	2	3	4	2x350	35	5500	5600	5600	5250	4850	5600	5700	5700	5350	4900
2		1	2	3	4	2x450	47	7100	7250	7250	6800	6250	7300	7450	7450	6950	6450
3		1	2	3	4	2x650	68	9700	9850	9850	9250	8450	10050	10200	10200	9600	8750
						700											
						750											
						800											
						850											
						900											
						950											
						1000											
						1050											

ON/OFF DALI		CCT 3500 K										
1	2	3	4	⚙️ [mA]	P <sub>g</sub> [W]	Φ <sub>g</sub> 30° [lm]	Φ <sub>g</sub> 60° [lm]	Φ <sub>g</sub> 90° [lm]	Φ <sub>g</sub> AS [lm]	Φ <sub>g</sub> OFF [lm]		
1	ON	1	2	3	4	2x350	35	5550	5650	5650	5300	4900
2		1	2	3	4	2x450	47	7200	7350	7350	6900	6350
3		1	2	3	4	2x650	68	9900	10000	10050	9450	8650
						700						
						750						
						800						
						850						
						900						
						950						
						1000						
						1050						

ON/OFF DALI		CCT 2700 K										
1	2	3	4	⚙️ [mA]	P <sub>g</sub> [W]	Φ <sub>g</sub> 30° [lm]	Φ <sub>g</sub> 60° [lm]	Φ <sub>g</sub> 90° [lm]	Φ <sub>g</sub> AS [lm]	Φ <sub>g</sub> OFF [lm]		
1	ON	1	2	3	4	2x300	32	4000	4050	4050	3850	3500
2		1	2	3	4	2x400	42	5150	5200	5200	4850	4500
3		1	2	3	4	2x600	62	6750	6850	6850	6450	6750
						650						
						700						
						750						
						800						
						850						
						900						
						950						
						1000						
						1050						



1

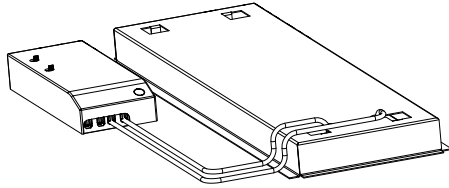

2

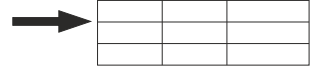
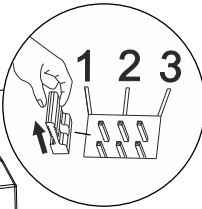
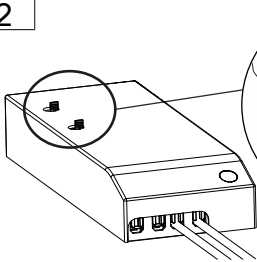

$P_{\text{max}}$  [W]



3

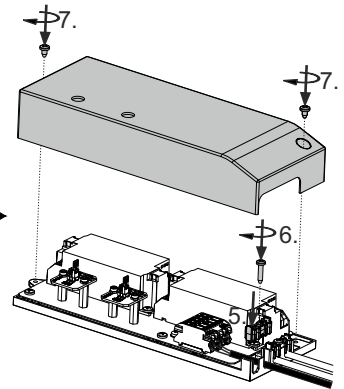
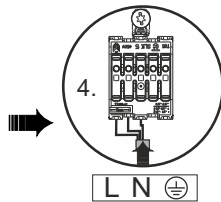
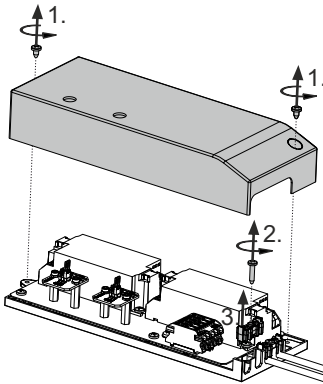

4

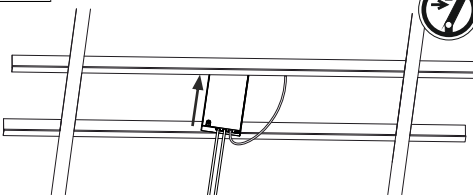

5

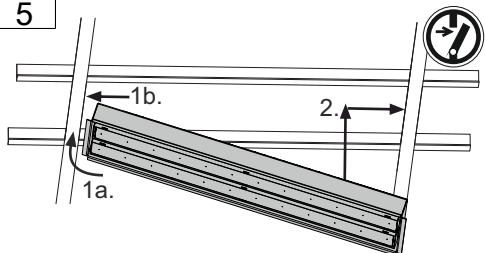

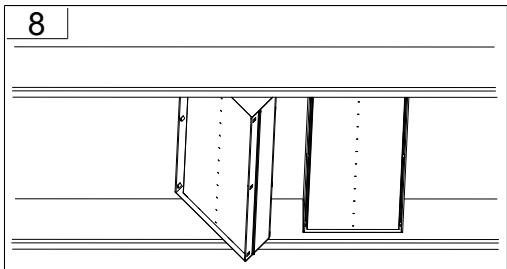
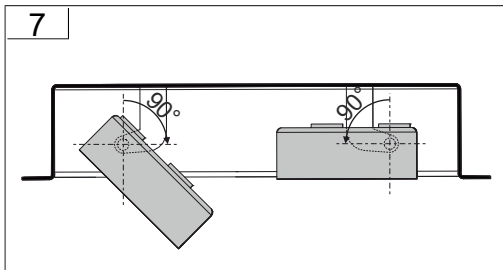
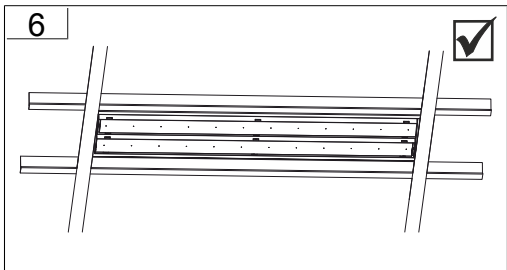

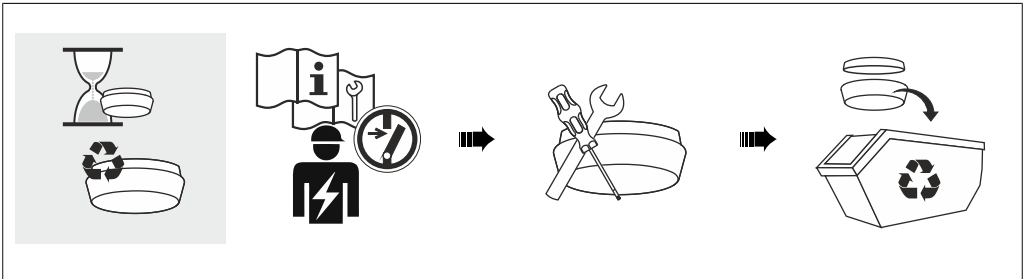
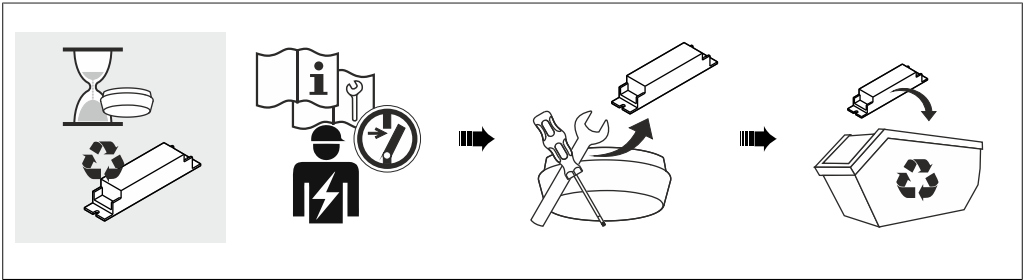
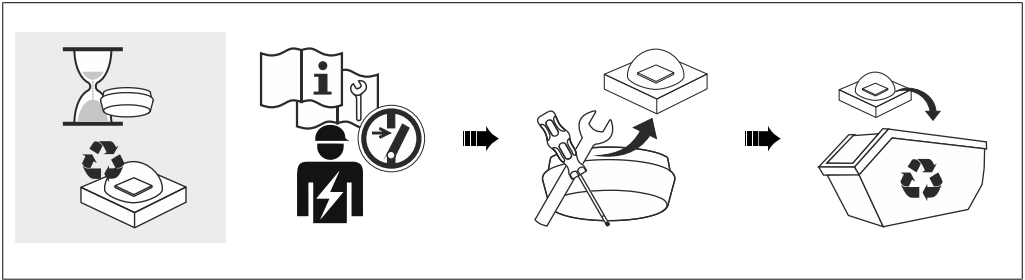









## Rastermaße / modular dimensions

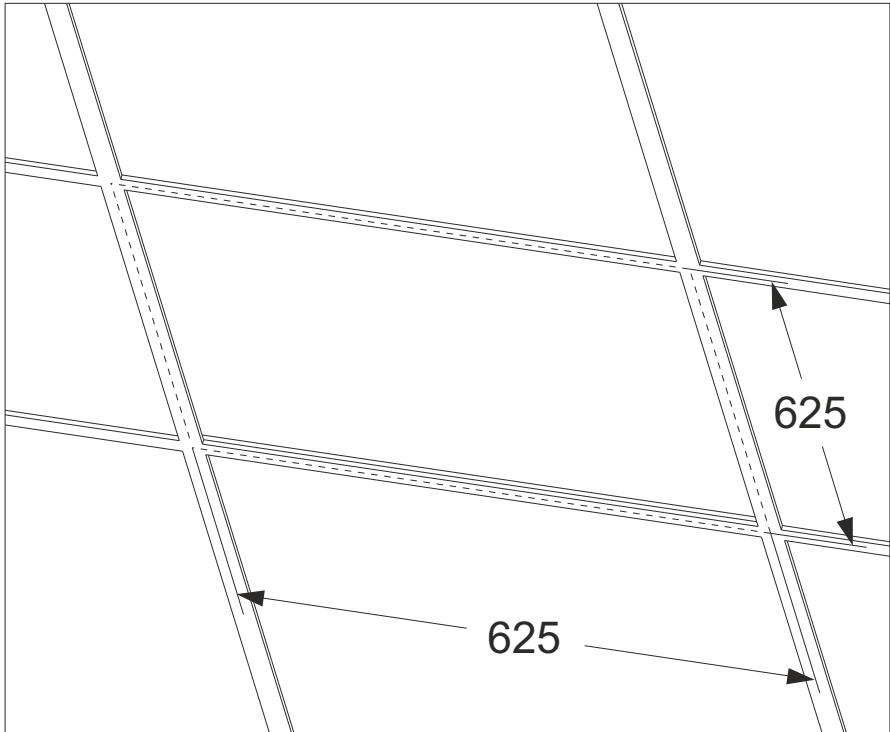

RZB - Rudolf Zimmermann, Bamberg GmbH

🏠 Rheinstraße 16, 96052 Bamberg

☎ 0951/7909-0

📄 0951/7909-198

🌐 [info@rzb-leuchten.de](mailto:info@rzb-leuchten.de)